

# Keysight Infiniium V-Series Oscilloscopes

# Notices

© Keysight Technologies 2015

No part of this manual may be reproduced in any form or by any means (including electronic storage and retrieval or translation into a foreign language) without prior agreement and written consent from Keysight Technologies, Inc. as governed by United States and international copyright laws.

## Manual Part Number

54919-97000

## Edition

First Edition, March 2015

Available in electronic format only

Published by:  
Keysight Technologies, Inc.  
1900 Garden of the Gods Road  
Colorado Springs, CO 80907 USA

## Warranty

**The material contained in this document is provided “as is,” and is subject to being changed, without notice, in future editions. Further, to the maximum extent permitted by applicable law, Keysight disclaims all warranties, either express or implied, with regard to this manual and any information contained herein, including but not limited to the implied warranties of merchantability and fitness for a particular purpose. Keysight shall not be liable for errors or for incidental or consequential damages in connection with the furnishing, use, or performance of this document or of any information contained herein. Should Keysight and the user have a separate written agreement with warranty terms covering the material in this document that conflict with these terms, the warranty terms in the separate agreement will control.**

## Technology Licenses

The hardware and/or software described in this document are furnished under a license and may be used or copied only in accordance with the terms of such license.

## Restricted Rights Legend

If software is for use in the performance of a U.S. Government prime contract or subcontract, Software is delivered and licensed as “Commercial computer software” as defined in DFAR 252.227-7014 (June 1995), or as a “commercial item” as defined in FAR 2.101(a) or as “Restricted computer software” as defined in FAR 52.227-19 (June 1987) or any equivalent agency regulation or contract clause. Use, duplication or disclosure of Software is subject to Keysight Technologies’ standard commercial license terms, and non-DOD Departments and Agencies of the U.S. Government will receive no greater than Restricted Rights as defined in FAR 52.227-19(c)(1-2) (June 1987). U.S. Government users will receive no greater than Limited Rights as defined in FAR

52.227-14 (June 1987) or DFAR 252.227-7015 (b)(2) (November 1995), as applicable in any technical data.

## Safety Notices

### CAUTION

A **CAUTION** notice denotes a hazard. It calls attention to an operating procedure, practice, or the like that, if not correctly performed or adhered to, could result in damage to the product or loss of important data. Do not proceed beyond a **CAUTION** notice until the indicated conditions are fully understood and met.

---

### WARNING

A **WARNING** notice denotes a hazard. It calls attention to an operating procedure, practice, or the like that, if not correctly performed or adhered to, could result in personal injury or death. Do not proceed beyond a **WARNING** notice until the indicated conditions are fully understood and met.

---

For more safety information, refer to the *For Your Safety* booklet included with your Infiniium oscilloscope.

## Infiniium V-Series Oscilloscopes—At a Glance

Model	Band width
MSOV084A, DSOV084A, DSAV084A	8 GHz band width
MSOV134A, DSOV134A, DSAV134A	13 GHz band width
MSOV164A, DSOV164A, DSAV164A	16 GHz band width
MSOV204A, DSOV204A, DSAV204A	20 GHz band width
MSOV254A, DSOV254A, DSAV254A	25 GHz band width
MSOV334A, DSOV334A, DSAV334A	33 GHz band width (typical)

The Infiniium V-Series oscilloscopes provide superior measurements, advanced probing, and go-to applications, helping you move rapidly from first silicon to crucial insights.

### Ease of use with high performance

The Infiniium V-Series oscilloscopes combine unprecedented ease-of use with high-performance digitizing oscilloscope functionality to simplify your design and analysis measurement tasks.

- Traditional oscilloscope front-panel interface provides direct access to the controls needed for most troubleshooting tasks.
- User interface with menus, windows, dialog boxes, toolbars, and wizards provides easy access to dozens of configuration and analysis tools, ensuring you can set up and make the most complex measurements.
- Models with bandwidths from 8 GHz to 33 GHz.
- All models feature 2 channels of 80 GS/s on all bandwidths.
- MSO models provide 10 GS/s at 16 channels and 20 GS/s at 8 channels.
- The high-speed hardware serial trigger option lets you quickly debug difficult problems, including discovering logic errors in your digital designs.

### Display shows waveforms and user interface

- User interface allows direct interaction with waveforms, including drag-and-drop positioning and instant waveform zoom.
- Large capacitive touch screen with multi-touch (gestures), handles, and resizing allows oscilloscope operation without an external pointing device.
- Waveforms are displayed in color, making correlation easy.
- Current configuration parameters displayed near the waveform display area are color-coded to make identification easy.
- Menus and toolbars simplify complex measurement setups.

Acquisition and general controls start and stop the oscilloscope and do basic setup

- Run and stop controls for continuous or single acquisitions.
- Clear display before one or more acquisitions.
- Default setup and Autoscale set initial configuration.

Removable solid-state drive and USB 2.0 and 3.0 ports for saving and restoring setups and measurement results

- Store measurement displays for inclusion in reports and test setup guides.
- Store oscilloscope setups to repeat tests another time.
- Hard disk stores oscilloscope operating system.

Trigger setup controls set mode and basic parameters

- Select Edge, Glitch, or Advanced Modes.
- Choose input source and slope.
- Use auxiliary trigger to increase triggering flexibility.

Vertical controls set attenuation and position

- Color-coded knobs make it easy to find the controls that affect each waveform.

Marker and quick measurements help measure waveform parameters

- Waveform markers 1 and 2 to check voltage or  $\Delta$ -time at any point on the displayed waveform.

## In This Book

This book provides the information you need to begin using the Infiniium V-Series oscilloscopes.

**Chapter 1**, “Setting Up the Oscilloscope,” starting on page 9 includes power and air flow requirements, plus other setup information.

**Chapter 2**, “Using the Oscilloscope,” starting on page 23 gives an overview of the front and back panel inputs and outputs, front-panel controls, and user interface, and tells you how to perform basic operations with the oscilloscope.

**Chapter 3**, “Online Help and Other Information,” starting on page 45 describes the Infiniium oscilloscope application’s online help contents and online demos. The online help describes how to use the Infiniium oscilloscope application in detail.

### For More Information

- For detailed information on how the oscilloscope makes measurements and how to use the oscilloscope, see the Infiniium oscilloscope application’s online help.
- For information on controlling the oscilloscope from a remote computer, see the *Oscilloscopes Programmer’s Reference* found in the Infiniium oscilloscope application’s online help.
- For information on testing and servicing the oscilloscope, see the *Service Guide* found in the Infiniium oscilloscope application’s online help.



# Contents

Infiniium V-Series Oscilloscopes—At a Glance / 3

In This Book / 5

## 1 Setting Up the Oscilloscope / 9

Inspecting Package Contents / 10

Specifications and Characteristics / 11

Positioning for Proper Airflow / 12

Connecting Accessories and Cables / 13

Connecting Power / 14



**Use Supplied Power Cord / 14**



**Properly Ground the Oscilloscope / 14**

Connecting Oscilloscope Probes / 15



**Maximum Input Voltage / 15**

Connecting Threaded RF Cables / 16

Tilting the Oscilloscope for Easier Viewing / 16

Turning On the Oscilloscope / 17

Verifying Basic Oscilloscope Operation / 18

Installing Application Programs on Infiniium / 19

Changing Windows Operating System Settings / 20

Turning Off the Oscilloscope / 21

Cleaning the Oscilloscope / 21

## 2 Using the Oscilloscope / 23

Front Panel Inputs and Outputs / 24

Channel inputs / 24

Ground / 24

Aux Out	/ 24
Cal Out	/ 24
Probe compensation terminal	/ 25
USB host ports	/ 25
Back Panel Inputs and Outputs	/ 26
Motherboard I/O	/ 26
10 MHz In, 10 MHz Out	/ 26
Trig Out	/ 27
Aux Trig	/ 27
Front Panel Controls (Keys and Knobs) Overview	/ 28
User Interface Overview	/ 29
Menu overview	/ 31
Using the Setup and Display Controls	/ 32
Starting and Stopping Waveform Acquisitions	/ 34
Adjusting the Horizontal Time Scale and Trigger Position	/ 35
Adjusting the Vertical Settings	/ 37
Setting Up Triggers	/ 39
Using Markers and Making a Measurement	/ 40
Saving and Printing Data	/ 43
Forcing a Default Setup	/ 44
<b>3 Online Help and Other Information</b>	<b>/ 45</b>
Accessing the Online Help	/ 45
Navigating the Online Help	/ 47
Using the Demo Wizard	/ 47
<b>Index</b>	<b>/ 49</b>



# 1 Setting Up the Oscilloscope

Inspecting Package Contents /	10
Specifications and Characteristics /	11
Positioning for Proper Airflow /	12
Connecting Accessories and Cables /	13
Connecting Power /	14
Connecting Oscilloscope Probes /	15
Connecting Threaded RF Cables /	16
Tilting the Oscilloscope for Easier Viewing /	16
Turning On the Oscilloscope /	17
Verifying Basic Oscilloscope Operation /	18
Installing Application Programs on Infiniium /	19
Changing Windows Operating System Settings /	20
Turning Off the Oscilloscope /	21
Cleaning the Oscilloscope /	21

This chapter shows how to set up your Infiniium oscilloscope, connect power and accessories, and verify general operation.

## Inspecting Package Contents

- ✓ Inspect the shipping container for damage.
  - Keep the shipping container or cushioning material until you have inspected the contents of the shipment for completeness and have checked the oscilloscope mechanically and electrically.
  - If the shipping container is damaged, or the cushioning materials show signs of stress, notify the carrier and your Keysight Technologies Sales Office. Keep the shipping materials for the carrier's inspection. The Keysight Technologies Sales Office will arrange for repair or replacement at Keysight's option without waiting for claim settlement.

- ✓ Inspect the oscilloscope.

If there is mechanical damage or a defect, or if the oscilloscope does not operate properly or does not pass performance tests, notify your Keysight Technologies Sales Office.

- ✓ Verify that you received the following items in the Infiniium oscilloscope packaging.

- Infiniium oscilloscope
- Power cord
- Keyboard
- Mouse (USB optical)
- Front panel cover
- Calibration cable
- Connector saver collars (kit of 10)
- Connector savers, 3.5mm f-f (quantity of 5)
- ESD wrist strap
- Quick Start Guide
- *For Your Safety* document
- Digital channels cable (MSO models only)
- MSO calibrator board assembly (MSO models only)

If anything is missing, contact your nearest Keysight Technologies Sales Office.

- ✓ Verify that you received the options and accessories you ordered and that none were damaged.

For a complete list of options and accessories available for the V-Series oscilloscopes, see the [\*Infiniium V-Series Oscilloscopes Data Sheet\*](#).

## Specifications and Characteristics

Environment	Indoor use only
Ambient Temperature	Operating 5 °C to +40 °C Non-operating -40 °C to +65 °C
Humidity	Operating: up to 95% relative humidity (non-condensing) at +40 °C Non-operating: up to 90% relative humidity at +65 °C
Altitude	Operating: up to 4,000 meters (12,000 feet) Non-operating: up to 15,300 meters (50,000 feet)
Installation Category	II
Weight	52.2 lbs.
Dimensions	10.5 in. tall (27 cm), 17.2 in. wide (44 cm), and 20.2 in. deep (51 cm)
Safety	IEC 61010-1:2010/EN 61010-1 3rd edition CAN/CSA-c22.2 No. 61010-1-12 UL 61010-1 3rd edition
Power Requirements	100-240 VAC ±10% at 50/60 Hz; Input power not to exceed 800 W
Voltage Fluctuations	The mains supply voltage fluctuations are not to exceed ± 10% of the nominal supply voltage.
Pollution Degree	The Infiniium V-Series oscilloscopes may be operated in environments of Pollution Degree 2.
Pollution Degree Definitions	<p>Pollution Degree 1: No pollution or only dry, non-conductive pollution occurs. The pollution has no influence. Example: A clean room or climate-controlled office environment.</p> <p>Pollution Degree 2. Normally only dry non-conductive pollution occurs. Occasionally a temporary conductivity caused by condensation may occur. Example: General indoor environment.</p> <p>Pollution Degree 3: Conductive pollution occurs, or dry, non-conductive pollution occurs which becomes conductive due to condensation which is expected. Example: Sheltered outdoor environment.</p>

## Positioning for Proper Airflow

- 1 Position the oscilloscope where it will have sufficient clearance for airflow around the back and sides.

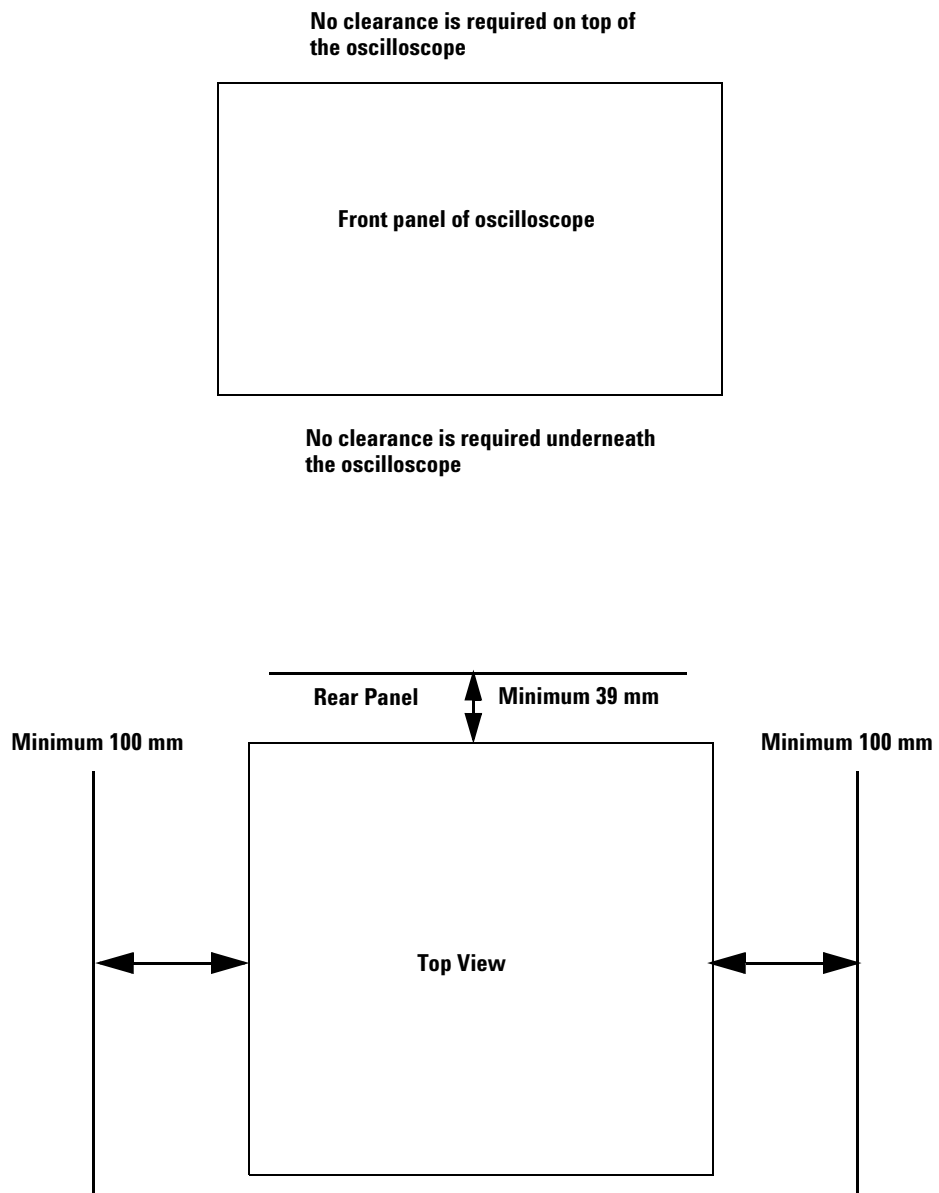

**Figure 1** Positioning the V-Series oscilloscope with sufficient clearance

**CAUTION**

Do not place the oscilloscope side-by-side with other instruments blowing warm air.

## Connecting Accessories and Cables

A mouse and keyboard can be plugged into the USB host ports. Four USB host ports are on the rear panel, with three more on the front panel.

Connect your LAN cable to the RJ-45 connector on the back panel of the oscilloscope.

### NOTE

After you have connected to the LAN card, you must set up the network. Exit the oscilloscope application before you start setting up your network.

If you do not know how to set up a network in the Windows 7 operating system, see your network administrator or use the Windows 7 operating system's online help.

If the oscilloscope is an MSO model, connect the digital channels cable to the accessory I/O connector, making sure to orient the cable as shown by the drawing on the back panel of MSO models. This connector is covered unless your oscilloscope is an MSO model or you purchased an accessory option.

### CAUTION

Be sure to orient the MSO cable as shown in the drawing on the back panel of MSO models. Inserting the cable incorrectly could bend the pins or cause errors.

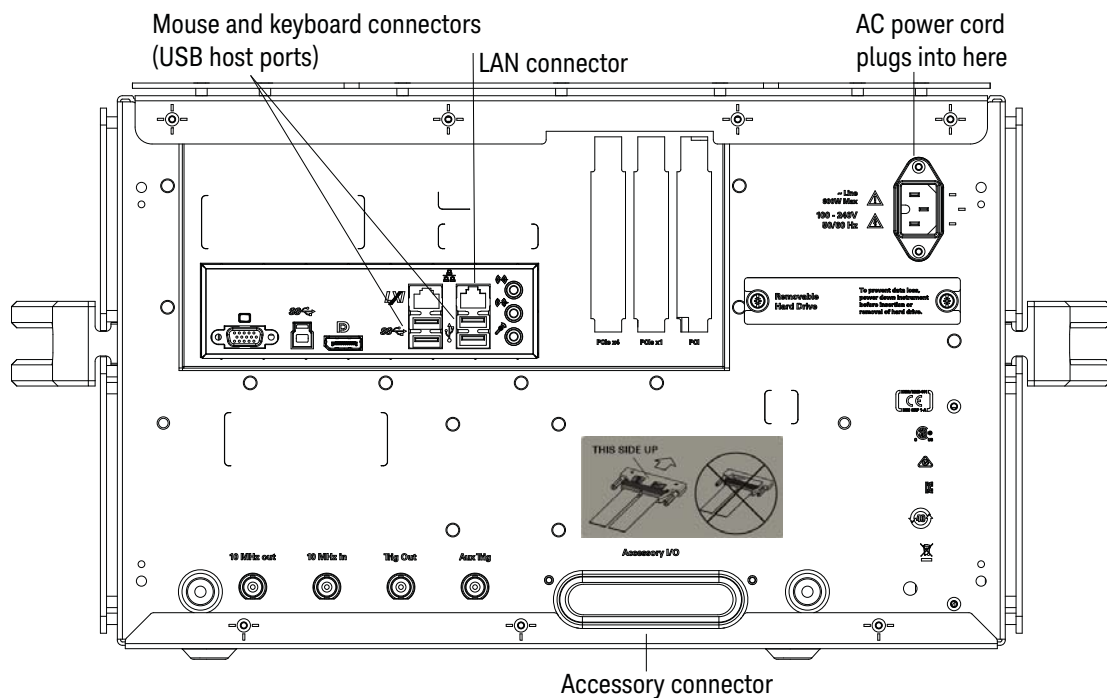

**Figure 2** Accessory and cable connectors

## Connecting Power

**Table 1** Power requirements

---

Power	100 - 240 VAC $\pm$ 10% at 50/60 Hz Input power not to exceed 800 Watts
-------	--

---

- Connect the power cord to the rear of the oscilloscope, then to a suitable AC voltage source.

**CAUTION**

**Use Supplied Power Cord**

Use only power cords designed for your oscilloscope.

The line cord provided is matched to the country of origin of the order.

---

**WARNING**

**Properly Ground the Oscilloscope**

**To avoid electric shock, be sure the oscilloscope is properly grounded.**

---

**NOTE**

Note that the oscilloscope's power supply has a built-in safety feature that, after the oscilloscope is turned off, requires the oscilloscope to remain off for about 10 seconds before it is turned back on.

---

## Connecting Oscilloscope Probes

### CAUTION

#### Maximum Input Voltage

Do not exceed the maximum input voltage rating.

Oscilloscope channels 1-4 are rated for maximum input of  $\pm 5V$  including transients.

The four Infiniium V-Series oscilloscope channel inputs have:

- 3.5 mm threaded RF connectors (like Keysight sampling oscilloscopes) to ensure the most reliable signal integrity.
- A convenient automatic torque mechanism that ensures a consistent 8 in-lbs connection.
- An AutoProbe II interface connector with pins that provide probe power, identification, and other communication signals.



**Figure 3** V-Series oscilloscope probe connectors

The AutoProbe II interface works with the InfiniiMax III probing system. There are four different InfiniiMax III probe amplifiers ranging from 16 to 30 GHz. For more information, see [Keysight Technologies InfiniiMax III/III+ Probing System Data Sheet](#).

Before using the InfiniiMax III probes, review the *InfiniiMax III Probe Handling Guide* included with the probes. These probes are ESD sensitive devices and there is a proper order for connecting probe amplifiers to the oscilloscope, probe heads to the device under test (DUT), and probe heads to the amplifier. You can also find the *InfiniiMax III Probe Handling Guide* on the Keysight web site ([www.keysight.com](http://www.keysight.com)) or with other Keysight oscilloscope probes documentation in the Probe Resource Center ([www.keysight.com/find/prc](http://www.keysight.com/find/prc)).

The N5442A Precision BNC 50  $\Omega$  adapter lets you use the InfiniiMax II probing system with the V-Series oscilloscopes.

## Connecting Threaded RF Cables

You can connect 3.5 mm threaded RF cables to the Infiniium V-Series oscilloscope inputs using the automatic torque “clutch” mechanism to ensure a consistent 8 in-lbs connection.

The **Aux Out** and **Cal Out** connectors also work with 3.5 mm threaded RF cables.

## Tilting the Oscilloscope for Easier Viewing

Tabs under the oscilloscope's front feet can be flipped out to tilt the oscilloscope.

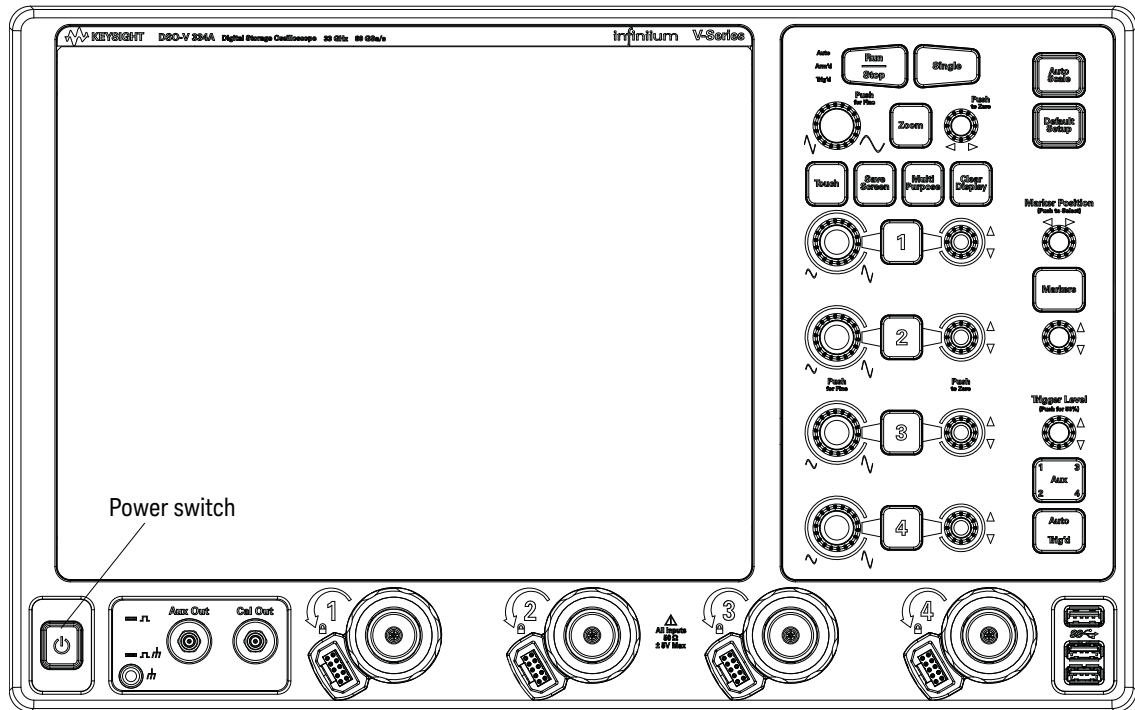

**Figure 4** Flip-Out tabs under front feet



## Turning On the Oscilloscope

- 1 Press the power switch in the lower left corner of the oscilloscope front panel.



**Figure 5** Turning On the oscilloscope

After a short initialization period, the oscilloscope display appears. The oscilloscope is ready to use.

- 2 You can connect and disconnect probes and cables while the oscilloscope is turned on.

## Verifying Basic Oscilloscope Operation

- 1 Install the supplied connector savers to each channel input. Keysight recommends using the connector savers to protect the input connectors.
- 2 Connect one end of the calibration cable to oscilloscope input channel 1.
- 3 Connect the other end of the calibration cable to the **Cal Out** connector on the front panel.

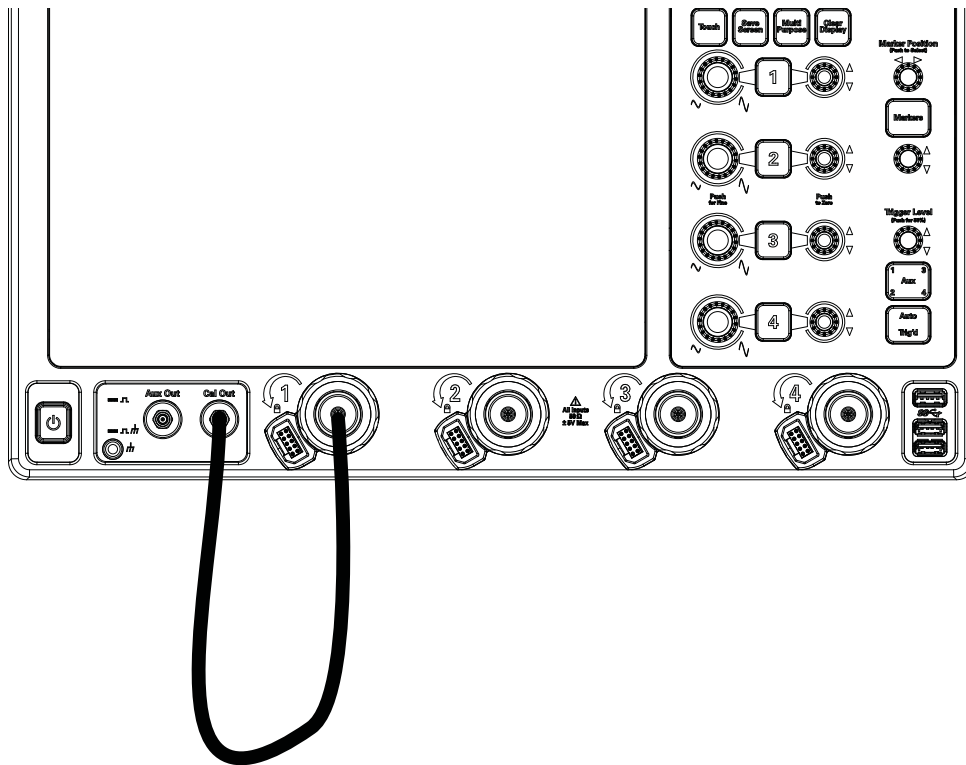

**Figure 6** Verifying basic oscilloscope operation

- 4 Press [**Default Setup**] on the front panel.

The display will pause momentarily while the oscilloscope is configured to its default settings.

- 5 Press [**Auto Scale**] on the front panel.

The display will pause momentarily while the oscilloscope adjusts the time/div setting and vertical scale. You should then see a square wave with about four cycles on screen and a peak-to-peak amplitude of approximately five divisions.

If you do not see the waveform, make sure your power source is adequate, the oscilloscope is properly powered on, and the probe is connected securely to the front-panel channel input and to the probe calibration output.

- 6 Move the mouse around the mouse surface and verify that the on-screen pointer follows the mouse movement.
- 7 Press the **[Touch]** key on the front panel to turn on the touch screen. Press and hold your finger to the screen. A right-click menu appears, which verifies that the touch screen is working properly.

## Installing Application Programs on Infiniium

Infiniium has an open Windows operating system, which lets you install your own application software. Any application that runs on Microsoft Windows 7 Embedded and uses 8 GB of RAM or less may be installed on your Infiniium oscilloscope.

**NOTE**

Exit the oscilloscope application before installing any software.

---

**CAUTION**

Installing an application that does not meet these requirements may break the oscilloscope application and require a hard drive recovery.

---

## Changing Windows Operating System Settings

**NOTE**

Exit the oscilloscope application before changing any Windows operating system settings outside of the oscilloscope application.

---

Many Windows operating system settings can be changed to suit your own personal preferences. However, some operating system settings should not be changed because doing so would interfere with the proper operation of the oscilloscope.

- Do not change the Power Options.
- Do not change the Language settings.
- Do not remove Fonts.
- Do not change the screen resolution from 1024 by 768 pixels.
- Do not use the Administrative Tools to enable or disable Internet Information Services. Use the Infiniium SCPI Server dialog box (**Utilities > Remote...**) to enable or disable the Web Server.
- Do not delete or modify the Infiniium Administrator user account.

## Turning Off the Oscilloscope

- Press the power switch at the lower left corner of the oscilloscope front panel. The oscilloscope will go through a normal Windows operating system shutdown process.

## Cleaning the Oscilloscope

Clean the oscilloscope with a soft cloth dampened with a mild soap and water solution.

**CAUTION**

Do not use too much liquid in cleaning the oscilloscope. Water can enter the Infiniium front panel, damaging sensitive electronic components.

---

## 1 Setting Up the Oscilloscope

## 2 Using the Oscilloscope

Front Panel Inputs and Outputs /	24
Back Panel Inputs and Outputs /	26
Front Panel Controls (Keys and Knobs) Overview /	28
User Interface Overview /	29
Menu overview /	31
Using the Setup and Display Controls /	32
Starting and Stopping Waveform Acquisitions /	34
Adjusting the Horizontal Time Scale and Trigger Position /	35
Adjusting the Vertical Settings /	37
Setting Up Triggers /	39
Using Markers and Making a Measurement /	40
Saving and Printing Data /	43
Saving and Printing Data /	43
Forcing a Default Setup /	44

This chapter describes how to use the Infiniium V-Series oscilloscope's inputs and outputs, front-panel controls, and user interface.

- The familiar front-panel oscilloscope interface with knobs and keys is optimized for common tasks and basic measurements.
- The Infiniium oscilloscope application's user interface with menus, windows, dialog boxes, and toolbars provides easy logical access to dozens of configuration and analysis tools, making it easy for you to set up and make complex measurements.
- You have the option of using either the front panel controls or the user interface for many common tasks.

## Front Panel Inputs and Outputs

On the Infiniium V-Series oscilloscopes, the channel inputs and the **Aux Out** and **Cal Out** outputs appear on the lower part of the front panel. The ground plug, probe compensation terminal, and three USB host ports are also located here.

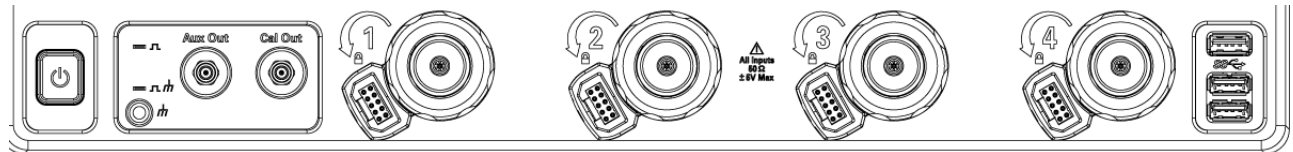

**Figure 7** Infiniium V-Series oscilloscope front panel I/O

### Channel inputs

The four channel inputs have:

- 3.5 mm threaded RF connectors.
- A convenient automatic torque mechanism.
- An AutoProbe II interface connector with pins that provide probe power, identification, and other communication signals.

The AutoProbe interface works with the InfiniiMax III probing system. See [“Connecting Oscilloscope Probes”](#) on page 15.

You can also connect 3.5 mm threaded RF cables to the channel inputs.

### Ground

The ground plug is convenient for ESD wrist straps.

### Aux Out

This output signal is selected by the Infiniium oscilloscope application's Calibration Output dialog box (**Utilities > Calibration Output...**). It can be a DC level, the probe compensation signal (a square wave used to adjust compensated passive probes), the trigger out signal, or a demo signal.

### Cal Out

This calibration output is used when performing a user calibration on the oscilloscope.

A calibration cable is included with the oscilloscope.



You can also use the Infiniium oscilloscope application's Calibration Output dialog box (**Utilities > Calibration Output...**) to select other output signals, just like you can for the **Aux Out** output.

## Probe compensation terminal

This terminal is located above the ground plug. It has a square wave signal that is used to adjust compensated passive probes. Be sure to use an N5449A high-impedance adapter.

You can also output a DC level on this terminal using the Infiniium oscilloscope application's Calibration Output dialog box.

## USB host ports

Three USB host ports are located on the right side of the front panel.

## Back Panel Inputs and Outputs

The Infiniium V-Series oscilloscope's back panel has the motherboard I/O connectors, reference clock synchronization connectors, and trigger I/O connectors.

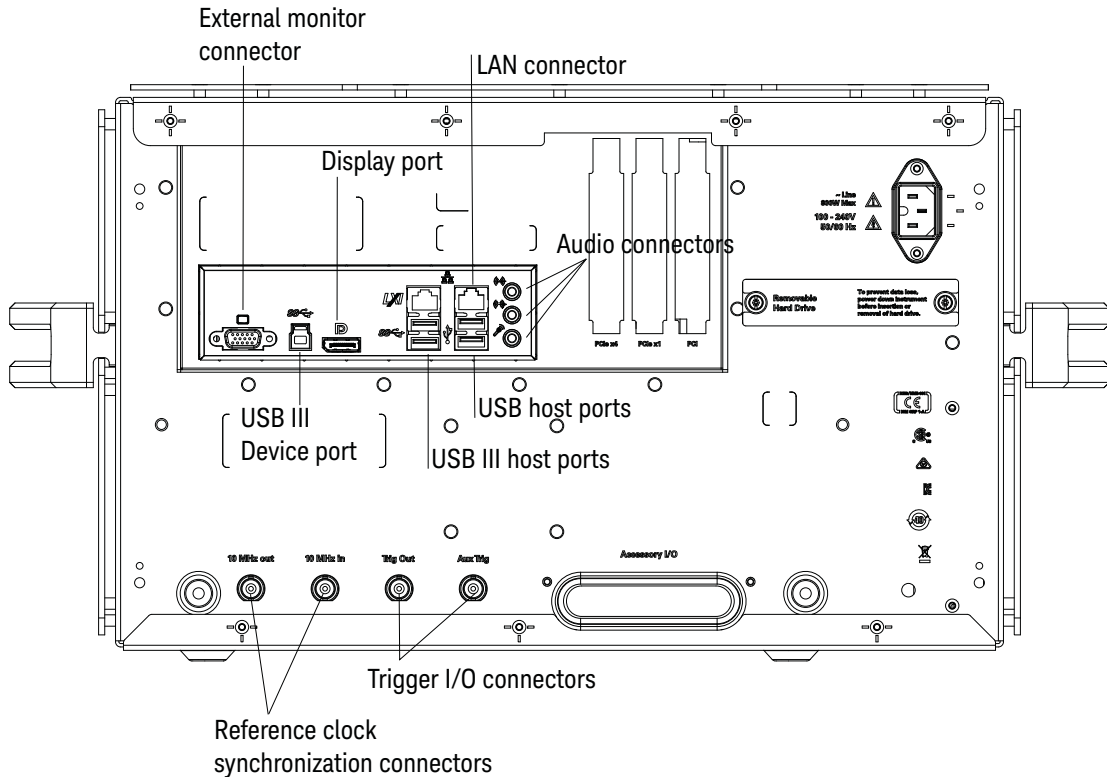

**Figure 8** Back panel I/O

### Motherboard I/O

The motherboard provides these inputs/outputs/ports in the oscilloscope: four USB ports for peripherals, an external monitor connector, a USB III device port (for remote control of the oscilloscope from a PC), a LAN port, and speaker and microphone connectors.

### 10 MHz In, 10 MHz Out

The 10 MHz In BNC connector is used to synchronize the oscilloscope's horizontal timebase system to a reference clock that you provide. The clock that you provide must meet the following specifications:

- Amplitude: 178 mV peak to 1 V peak.
- Frequency: 10 MHz  $\pm$ 5 ppm high-quality sine wave or square wave.

To use an external reference clock, connect the external clock to the 10 MHz In BNC connector; then, in the Infiniium oscilloscope application's Horizontal dialog box (**Setup > Horizontal...**), enable the 10 MHz External Reference Clock.

You can use the 10 MHz Out BNC connector to send the oscilloscope's 10 MHz reference clock output signal to another instrument's reference clock input.

## Trig Out

Pulses corresponding to oscilloscope triggers can be sent to this BNC output.

## Aux Trig

You can set up the oscilloscope to trigger on the auxiliary trigger signal connected to this BNC input.

## Front Panel Controls (Keys and Knobs) Overview

The Infiniium V-Series oscilloscope front panel gives you direct access to the functions needed to perform the most common measurements, using a traditional oscilloscope interface. Knobs and keys let you directly set vertical and horizontal parameters. The front panel also has a set of LED indicators; by using these and the display, you see the oscilloscope's configuration at a glance.

The oscilloscope uses color consistently throughout the front panel and user interface. For example, the color of the knob for channel 1 is the same color as the waveform for channel 1. All the configuration items and values related to channel 1 are displayed in the same color.

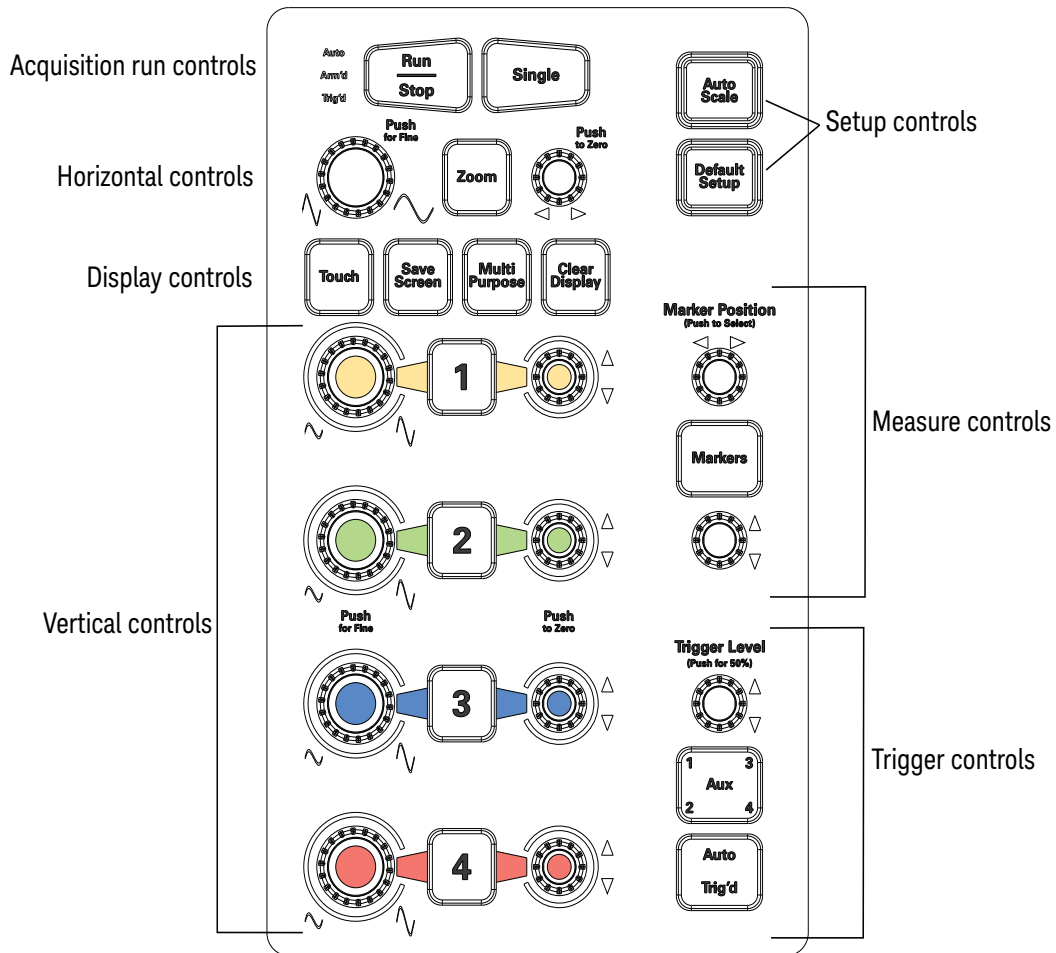

**Figure 9** Infiniium V-Series oscilloscope front panel

## User Interface Overview

With the user interface for the Infiniium oscilloscope, you can access all of the configuration and measurement features of the oscilloscope through an easy-to-use system of windows, menus, toolbars, dialog boxes, icons, wizards, and buttons.

The user interface is arranged so the most common functions affecting the waveform display are located around the edge of the waveform display area.

Context-sensitive menus are available when you right-click something in the waveform display area, such as the grid, a signal, a bookmark, or a measurement. You can mouse over or touch other areas, such as the drag & drop measurements area and horizontal and acquisition control regions, to find more information about those areas or to enter data.

The following figures call out the areas and controls of the user interface.

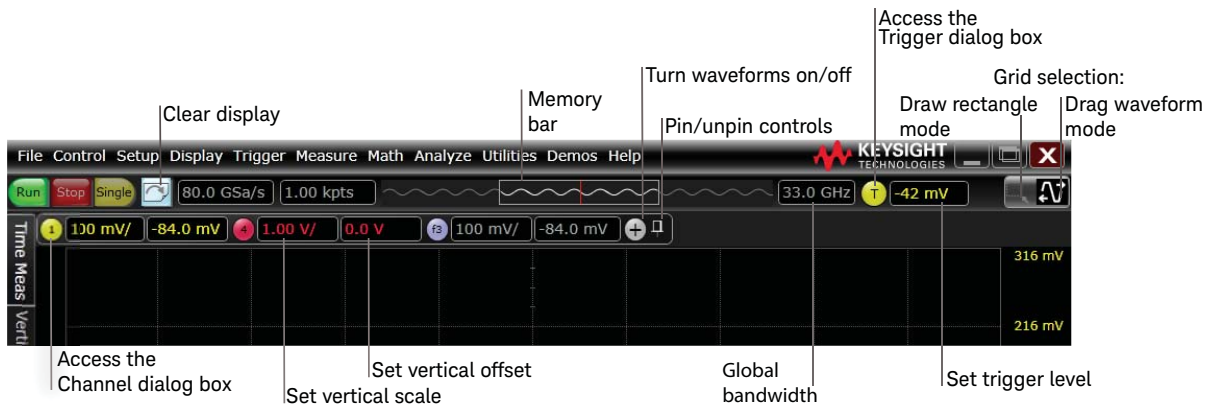

**Figure 10** Infiniium oscilloscope top of display

The selected grid mode in the upper right corner determines whether you draw a selection box or manipulate waveforms when you touch the screen.

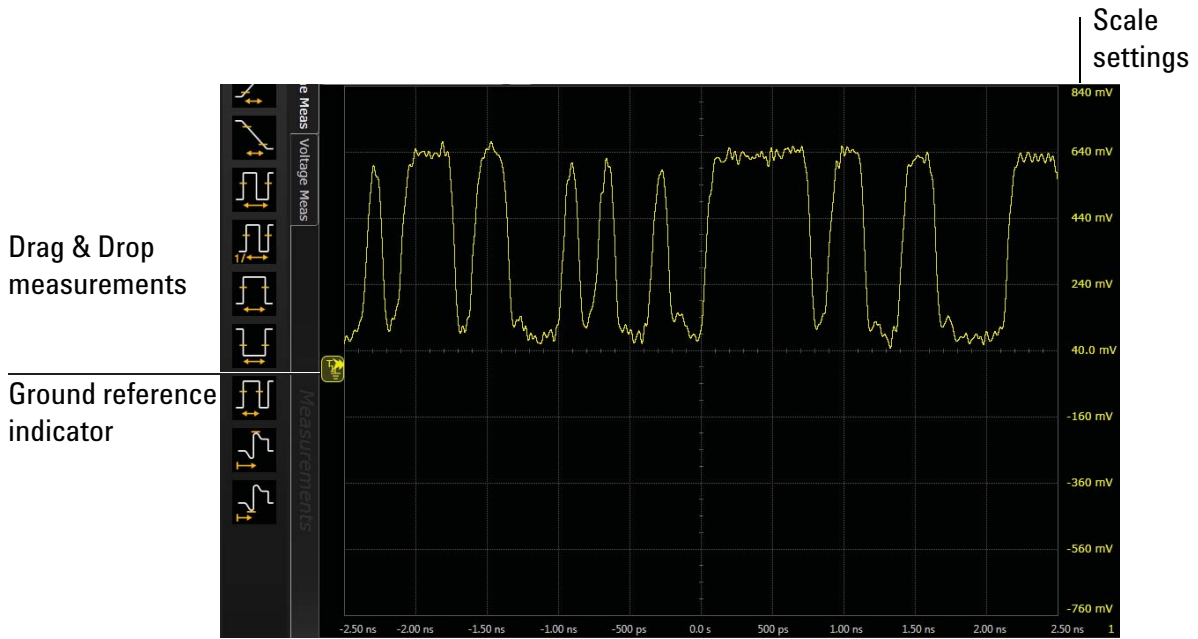

**Figure 11** Infiniium oscilloscope waveform display area

The waveform display area shows up to eight waveform windows. Several display options are available, such as grids or horizontal and vertical scales.

**NOTE**

**Avoid Overdriving Vertical Input Amplifiers**

When zooming on a waveform with the oscilloscope running, be careful to keep the signal within the screen vertically to avoid overdriving the vertical input amplifiers. Overdriving causes waveform distortion and erroneous measurement results.

Ground reference indicators appear for each displayed channel, waveform memory, or math function waveform. The symbol represents the ground reference point for each waveform; it moves when you change the vertical offset. You can also drag this symbol up and down to change the vertical offset for that waveform.

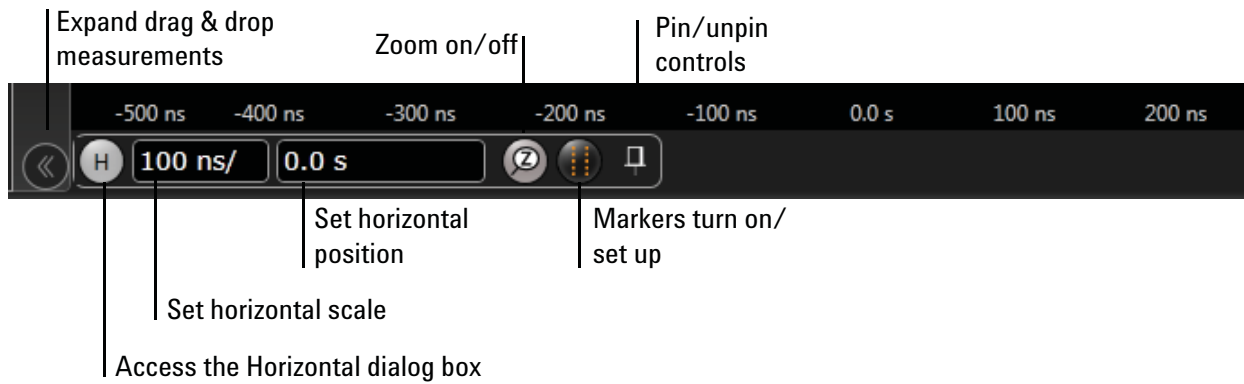

**Figure 12** Infiniium oscilloscope bottom of display

A Results pane is visible at the very bottom of the display when you do something that requires it, such as take a measurement. When it is not needed, the Results pane is not visible.

## Menu overview

You can use menus to perform defined operations, set up measurement parameters, and access every function the oscilloscope provides.

Take a few minutes to look through the menus to get an overview of the many features and capabilities of your Infiniium oscilloscope.

The sub-menu selections will vary slightly, depending on which licenses are installed.



**Figure 13** Menu bar

## Using the Setup and Display Controls

With the setup and display controls you can set the oscilloscope to a known starting condition, set the display to suit your preference, and define a key to perform automatic measurements or other quick actions.

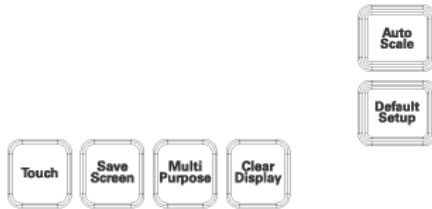

**Figure 14** Setup and display control keys

- To automatically configure the oscilloscope for the current input signal(s), press **[Auto Scale]** or choose **Control > Autoscale** from the main menu.
- To reset the oscilloscope to its default setup, press **[Default Setup]** or choose **Control > Default Setup**. Choose **Control > Undo Default Setup** to return the oscilloscope to its original configuration.

### NOTE

#### Save the Current Oscilloscope Configuration

Before using the default setup, you may want to save the current oscilloscope configuration for later use. See the online help (described in chapter 3) for instructions on saving and recalling setups, and for information on the exact configuration that is set when you use the default setup.

#### Using the touch screen

- To enable or disable the touch screen so it responds to multi-touch gestures, similar to those used on tablets and smart phones, press the **[Touch]** key. Or, choose **Utilities > User Preferences...** to enable the touch screen from the User Preferences dialog box.
  - Touch the drag waveform icon near the upper right corner of the display to highlight it.
  - Use gestures to flick items horizontally, drag a waveform vertically, drag horizontally to change the horizontal delay, pinch horizontally to adjust time/div and delay settings, pinch vertically to adjust a waveform's V/div and offset settings, or tap to select waveforms.

#### Saving the screen image

- To save the screen image to a file for use in other programs or documents, press the **[Save Screen]** key or choose **File > Save > Screen Image...**



- The first time you save a screen image you will be prompted to enter a location for the saved file. Subsequent saves automatically place the file in that location.

### Using quick measurements

- You can define the **[Multi Purpose]** key to perform one of these quick actions:
  - QuickMeas—performs automatic measurements
  - QuickPrint—prints the screen image to the default printer
  - QuickScreen—saves the screen image to a file
  - QuickSetup—loads a setup file
  - QuickWaveform—saves waveform data to a file
  - QuickEmail—sends an email of the current screen image
  - QuickExecute—runs an executable file
  - QuickControl—cycles through the possible front panel control sources

The action taken when the **[Multi Purpose]** key is pressed (or **Utilities > Multipurpose** is chosen) depends on the feature selected in the Customize Multipurpose dialog box (**Utilities > Customize Multipurpose...**). The default feature is QuickMeas.

- To turn on the quick measurement display, press the **[Multi Purpose]** key.

The 10 preset measurements defined in the Quick Measurement configuration are enabled and results appear on the screen for the first waveform source.

- To measure parameters for another waveform, press the **[Multi Purpose]** key until that waveform is the one shown in the measurement readout. Continuing to press the **[Multi Purpose]** key cycles through each of the waveforms available.
- To turn off the quick measurement display, cycle through all channels until the measurements are turned off.

See the Infiniium oscilloscope application's online help for information on how to configure the quick measurement capability.

### Clearing the waveform display

Press the **[Clear Display]** key or click the Clear Display  button.

The oscilloscope clears acquired waveform data from the display in preparation for another acquisition. If the oscilloscope is in Run mode and is receiving triggers, it will update the display as it collects new waveform data.

Clearing the waveform display also resets averaging, infinite persistence, color grade persistence, histograms, measurement statistics, and the mask testing database.

## Starting and Stopping Waveform Acquisitions

Use the acquisition run controls to run and stop acquisitions or make a single acquisition. The boxed area of the memory bar above the waveform display area shows which portion of the channel's acquisition memory you are viewing.



**Figure 15** Acquisition run control keys and buttons

The **[Run/Stop]** key is lit green and the green Run button is highlighted when the oscilloscope is running (acquiring data). The **[Run/Stop]** key is red and the Stop button is highlighted when the acquisition is stopped.

- To start waveform acquisition, press the **[Run/Stop]** key or click the Run button. The oscilloscope begins acquiring data. When it receives a trigger signal, it finishes acquiring data, updates the display, and then starts another acquisition cycle if it is in Trig'd or Auto trigger mode.
- To stop waveform acquisition, press the **[Run/Stop]** key or click the Stop button. Whatever data was last acquired remains on the screen.
- To make a single acquisition, press the **[Single]** key or click the Single button.
- You can also click the Run, Stop, and Single commands from the Control menu.
- To set up how you want the signals to be sampled, such as sampling rate and mode, click **Setup > Acquisition...**

## Adjusting the Horizontal Time Scale and Trigger Position

Use the horizontal controls to configure the horizontal scale (time per division) and horizontal position of the waveform. You can view a magnified section of the waveform using the zoom window.

Use gestures on the touch screen to adjust the horizontal scale and position. You can also use the horizontal knobs, horizontal controls, or Horizontal dialog box.

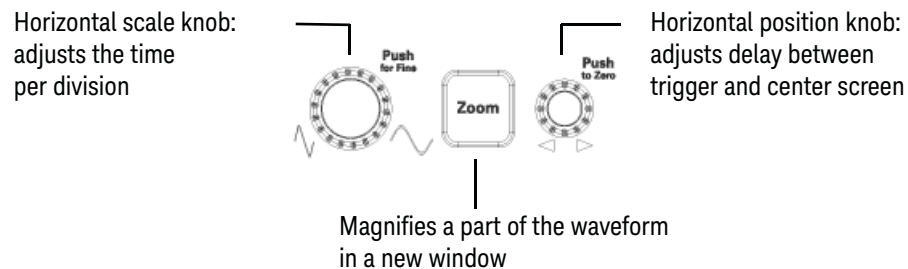

**Figure 16** Horizontal scale and position knobs, **[Zoom]** key

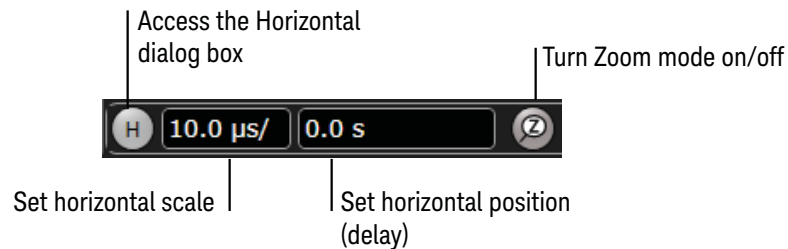

**Figure 17** User interface horizontal controls

### Adjusting the horizontal scale

- The horizontal scale knob is the larger of the two horizontal control knobs. To stretch the waveform horizontally, turn the horizontal scale knob clockwise. To shrink it horizontally, turn the knob counter-clockwise.

Stretching the waveform means fewer seconds are displayed per division. Shrinking it means more seconds are displayed per division.

- Push and turn the horizontal scale knob to change the scaling in finer (Vernier) increments.
- You can use multi-touch gestures to stretch or shrink the waveform.
- You can also use the controls in the horizontal toolbar to adjust the horizontal scale. Mouse over or touch the horizontal scale field and use the resulting controls to set a particular horizontal scale. You can click the **Scale** field to enter an exact value, or click the “narrower” or “wider” buttons.

### Adjusting the horizontal trigger position (delay)

- The horizontal position knob is the smaller of the two horizontal control knobs. Turn it to move the waveform to the right or left.

Moving the waveform to the right shows more of the pre-trigger data (data acquired before the trigger event). Moving the waveform to the left shows more of the post-trigger data.

When you drag the desired waveform, the horizontal position will change for all channels and functions on the display. Waveform memories will also move if you check the Tie To Timebase box in the Waveform Memories dialog box.

- You can also use the controls in the horizontal toolbar to adjust the horizontal position. Mouse over or touch the horizontal position field and use the resulting controls to set a particular horizontal position (time relative to the trigger at the highlighted horizontal reference point).

### Magnifying a part of the waveform using Zoom

- To turn on zoom, press the **[Zoom]** key or click the Zoom button.

The waveform display area splits into two regions. The top one is the main timebase. The bottom is the zoomed timebase, which represents an expansion of the acquired waveform data. A section of the waveform in the main timebase window is highlighted to indicate the part shown in the zoomed timebase window.

The horizontal scale and horizontal position controls now change how the waveform is shown in the zoomed timebase window. The horizontal scale will change the amount of magnification, while the position will change the part of the waveform in the main window that is shown in the zoomed window.

- Press the **[Zoom]** key or click the Zoom button again to turn off Zoom.

### Setting the scale, position, and timebase reference point

You can use the Horizontal dialog box to set scale, position, and timebase reference. You can also set up the zoomed timebase window.

- To access the Horizontal dialog box, click the  in the horizontal toolbar, or click **Setup > Horizontal...** from the menu bar.
- The Timebase Reference control is a slider from 0 to 100% of the screen. The center of the screen is at 50%. The slider correlates to the solid orange triangle at the bottom of the display area, showing you where the horizontal offset is on the screen.

## Adjusting the Vertical Settings

Use the vertical controls to set the vertical scaling (volts per division) and vertical offset for each analog channel. You can also turn the display on or off for a particular channel.

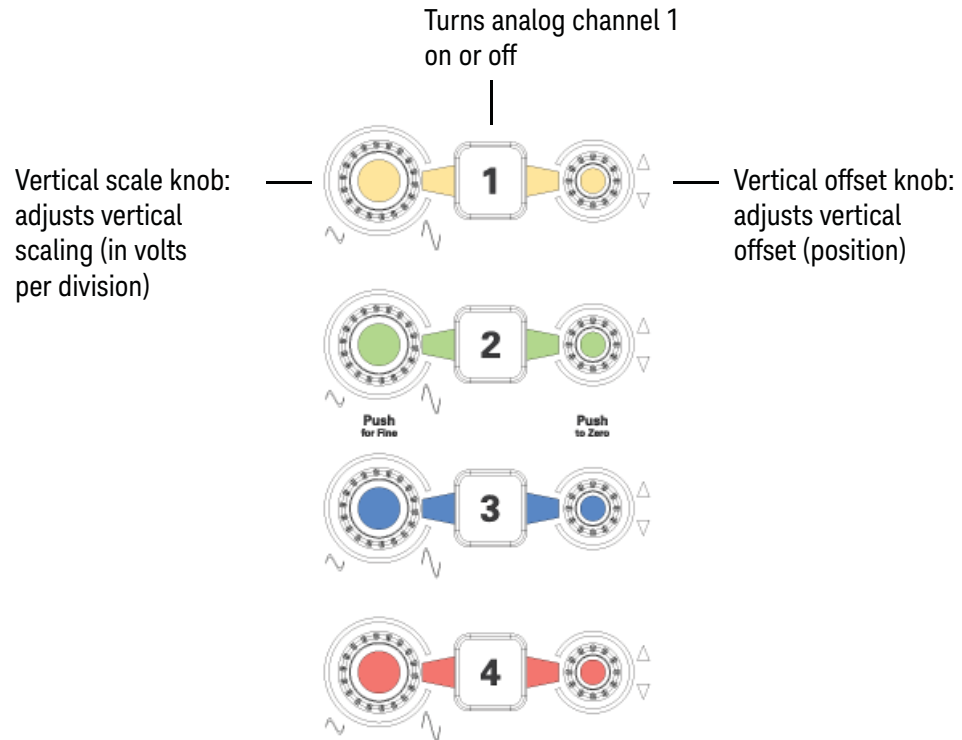

**Figure 18** Channel keys and vertical scale and offset knobs

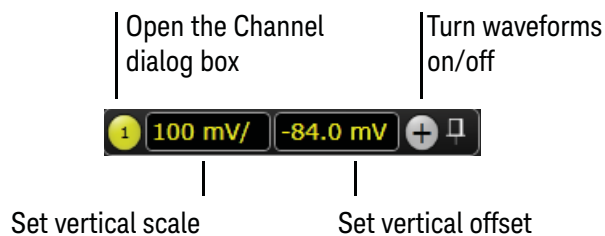

**Figure 19** User interface vertical controls

### Turning an analog channel on or off

- To turn an analog channel on or off, press the channel number key on the front panel or click the Add Waveforms button . When you turn off a channel, the current vertical scale and offset fields for that channel disappear.

If you are not using a particular analog channel, you can turn it off to simplify the waveform display and increase the display update rate. Functions continue to run on a channel source that is turned off. Data acquisition continues for a channel if a function requires it.

#### NOTE

#### Using an Analog Channel as Trigger

Any analog channel can be used as a trigger source. If you need a trigger but do not need all analog channels, you can use an analog channel as a trigger without displaying it by turning the analog channel display off.

### Adjusting the analog channel's vertical scale and offset

You can use the vertical scale and offset knobs, the vertical user interface controls, or the Channel dialog box to adjust the vertical scale and offset.

- The vertical scale knob is the larger of the two knobs for a channel. Turn it to make the waveform bigger (fewer volts per division) or smaller (more volts per division).
- You can also mouse over or touch the vertical scale field and use the resulting controls to set an exact value for the scaling.
- The vertical offset knob is the smaller of the two knobs for a channel. Turn it to move the waveform up or down.
- You can click and drag the waveform or its ground reference indicator to the desired vertical offset if the grid is in drag mode .
- Click **Setup > Channel N...** or click a channel number to open the Channel dialog box, in which you can set the vertical scale, offset, skew, and labels. You can also specify the characteristics of a probe, or perform a probe calibration.

For Keysight Technologies probes that are compatible with AutoProbe II interfaces, the oscilloscope will automatically set these characteristics (except for skew) after identifying the probe when it is connected to the channel input.

## Setting Up Triggers

Use the trigger controls to set the conditions on which the oscilloscope will trigger and acquire an input signal. You can set up a variety of trigger conditions. Edge triggers and the parameters for edge triggering can be set up from the front panel.

Trigger configuration settings you make using the user interface are reflected in the front-panel status indicators, and will remain set unless you change them or press the **[Default Setup]** key.

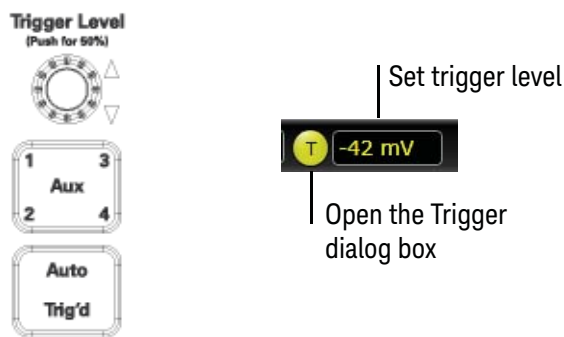

**Figure 20** Trigger controls and indicators

### Setting the oscilloscope to trigger on an edge

- 1 Press the **[Aux]** key until the desired trigger source LED is illuminated.

You can choose any of the channels or the **Aux** input as the source for an edge trigger.

- 2 Press the **[Auto/Trig'd]** key until the desired one is selected.

When Auto is selected, if a trigger does not occur within a certain amount of time, an acquisition is automatically saved and displayed. In Auto trigger mode, you are able to see your signals while setting up the desired trigger.

When Trig'd is selected, the oscilloscope must find the trigger before saving and displaying captured data.

- 3 Turn the Trigger Level knob to adjust the voltage level at which the oscilloscope will trigger.

Use the Trigger dialog box to select any of the different modes of triggering, the parameters and conditions for each trigger mode, and advanced configuration items.

You can also mouse over the Trigger Level field and use the resulting controls to set a particular trigger level when the scope is set for edge trigger on a particular channel. You can also drag the trigger reference indicator at the left side of the display, or drag the trigger line itself, which appears when you click or touch the grid.

## Using Markers and Making a Measurement

Use the measure controls to display and adjust markers and make measurements.

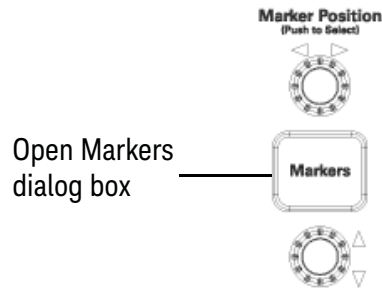

**Figure 21** Front panel measure controls

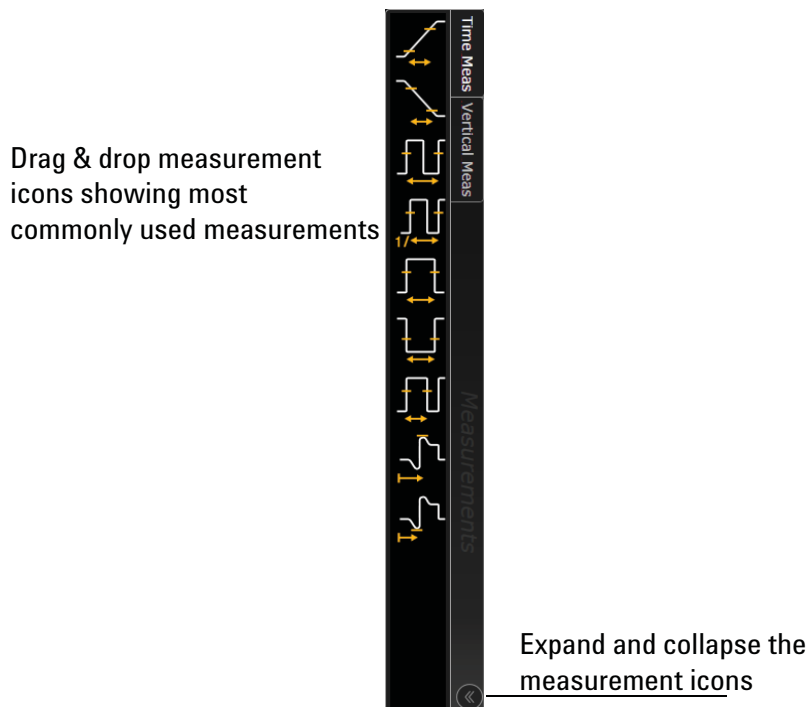

**Figure 22** User interface drag & drop measurements

### Making a measurement on a waveform

Click and drag a measurement icon to the waveform event you want to measure, or click a measurement icon and specify which source you want to measure in the dialog box that appears.



For measurements on waveform features, such as those that involve waveform edges, if you click a measurement icon and specify a source, the measurement defaults to using the feature closest to the horizontal reference point. When you make the measurement using drag-and-drop, the measurement uses the waveform feature closest to the point where you drop the icon.

The most commonly used measurements are available in the drag and drop area. Others are available from the Add Measurement dialog box.

When you drag and drop a measurement icon on a waveform, the icon outline changes color to match the color of each waveform it touches so you can easily see which waveform will be measured when you release.

For edge-sensitive measurements, when you drop the measurement icon on a waveform, a circled number appears in the waveform marker color. This number shows exactly where the measurement is being made. It is displayed next to the measurement readout in the Results area.

This feature helps you distinguish measurement results from each other when you make multiple measurements on the same waveform, but at different waveform features.

## Using markers

Markers make it easier to make precise measurements because the marker measurement readouts show exact voltage and time positions for the markers. The measurements are based on actual waveform data from the acquisition system, not on approximations based on the display position, so you can be sure the values are highly accurate.



Using the marker and measurement controls, you control two sets of markers within the oscilloscope grid.

Both time and voltage differences between the markers are updated continuously on the screen. By default, the markers track the source waveform. Voltage measurements from the markers are the value of the waveform at the time set with the marker arrow keys.

- To select the type of marker mode you want to use, press the **[Markers]** key and select the mode in the pop-up dialog box.
- Set the parameters in the Markers dialog box.
- Marker 1 has a solid line pattern and Marker 2 has a dashed line pattern on the waveform display. Each is associated with the first available source on the display.
- To move a horizontal marker, turn the upper Marker Position knob. To move a vertical marker, turn the lower knob.
- Push the respective knob to toggle between Marker 1 and Marker 2.
- In Track Measurements mode, the marker position cannot be changed.

- Drag a marker to quickly move it to the desired waveform event. You can use the Marker Position knobs for fine adjustment, or click **Measure > Markers...** or the Markers button  and set the marker position precisely.

### Controlling digital channels

- If your oscilloscope is an MSO model or has the digital channels upgrade, click **Setup > Digital Channels...** to open the Digital dialog box so you can set up controls for the digital channels and turn them on.
- To easily turn the digital channels on, press the Add Waveforms button  and select the check box next to the .

## Saving and Printing Data

- Click **File > Save >** to save your composite, setup, waveform, screen image, or measurement data. You can also save to a waveform memory.
- Click **File > Print...** to send waveform and setup data to a specified printer.
- Click **File > Copy Screen Image** to easily copy and paste a screen image into a document.
- You can customize the **[Multi Purpose]** key to perform a QuickPrint.

## Forcing a Default Setup

If your Infiniium oscilloscope is not working properly when you start it up, follow these steps to perform a default setup and return the oscilloscope to normal operation.

- 1 Click **Control > Default Setup** or press the **[Default Setup]** key.
- 2 If the oscilloscope is still not working properly, click **Control > Factory Default** to return the oscilloscope to the default settings it had when it left the factory.
- 3 If the oscilloscope is still not working properly, turn it off.
- 4 Turn the oscilloscope back on. If it does not successfully restart, try recycling the power again.
- 5 As soon as the Windows 7 load screen disappears, press **[Default Setup]**. If the oscilloscope still does not successfully restart, follow the instructions for recovering the hard drive.

### Infiniium hard drive recovery

Follow these steps to recover your Infiniium hard drive.

- 1 Turn off the oscilloscope.
- 2 Connect the keyboard and mouse to the USB host ports on the back of the oscilloscope.
- 3 Turn on the oscilloscope.
- 4 As soon as you see the message **press F2 to boot the Infiniium Recovery System**, press **[F2]** and follow the on-screen instructions.
- 5 Once the recovery process is finished and the oscilloscope is running, check in the About Infiniium dialog box under installed options to see if all of the options you ordered are installed. If the options are not installed, install them using the license keys provided on the oscilloscope option license certificates you received, or refer to the back of the oscilloscope.

# 3 Online Help and Other Information

Accessing the Online Help / 45

Navigating the Online Help / 47

Using the Demo Wizard / 47

Most of the information about using the Infiniium oscilloscope effectively is included in the online help.

To access the online help, click **Help > Contents...** from the menu bar or click the question mark in the top right corner of dialog boxes.

## Accessing the Online Help

- Click **Help > Contents...**

The Using the Oscilloscope topic appears on the home page. It looks like the following figure.

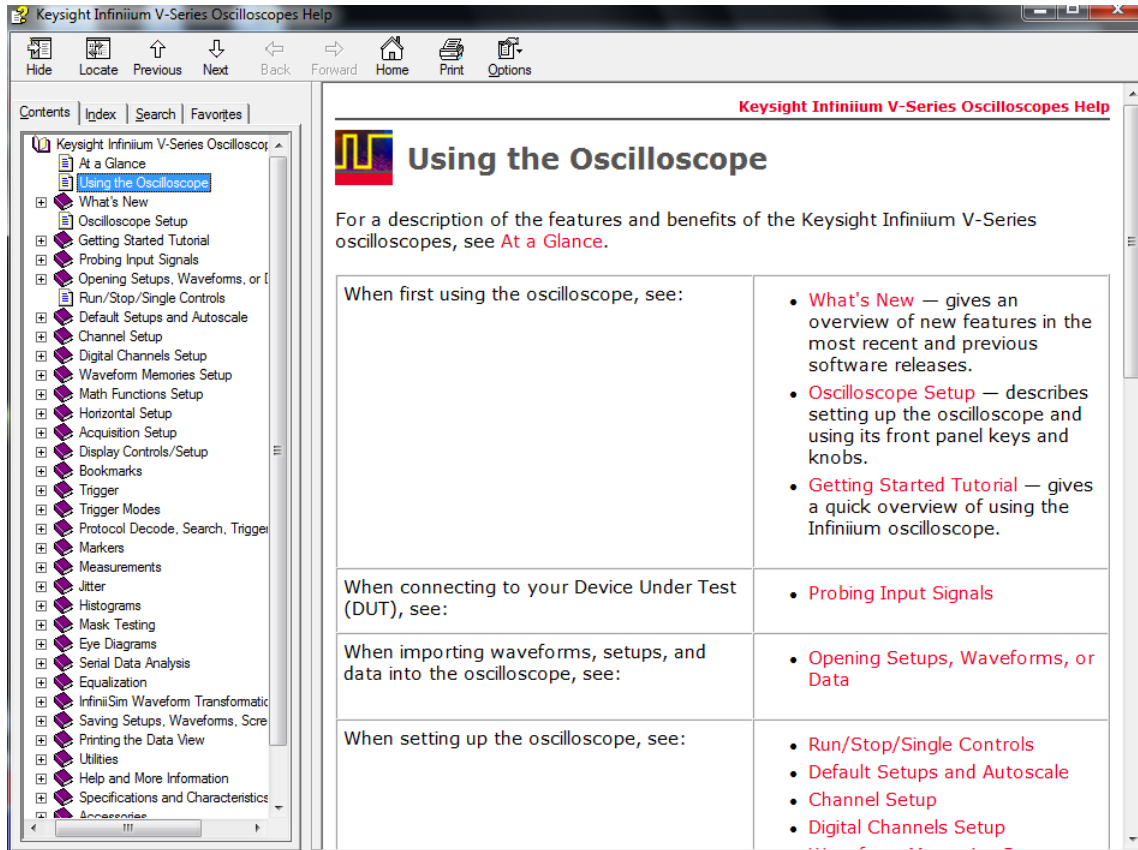

Figure 23 Online Help Home Page

**NOTE**

**Viewing the Online Help Window**

The online help window stays on top of the interface display, so you can refer to it while working with the oscilloscope. You can move the window around the screen or resize it to make it easier to use.

- For information about items in a dialog box, click the Help button  in that dialog box.

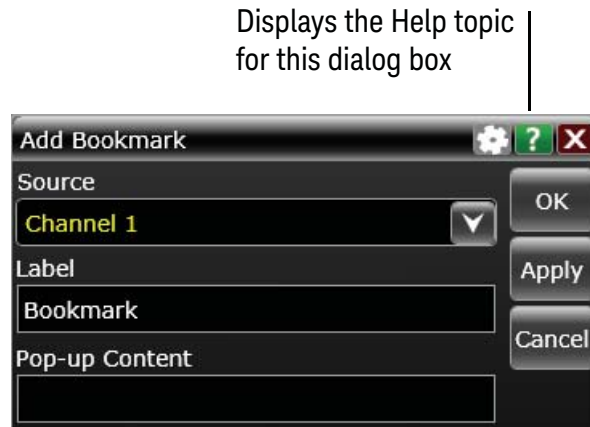

**Figure 24** Help Button for Dialog Box Help

## Navigating the Online Help

The online help provides several ways to find the information you need.

Use the Contents tab to browse topics in the help system by clicking topics in the left pane.

Use the Index tab to type in a keyword and search the index for that keyword or scroll through the list to find a topic.

Use the Search tab to type in a keyword and if that word exists in the online help, a list of topics containing the keyword appears.

Use the Favorites tab to add preferred help topics to a list for easy reference.

## Using the Demo Wizard

Your V-Series oscilloscope comes with a built-in demo wizard that showcases many of the oscilloscope's capabilities. To see the demos, click **Help > Show Demo Wizard....** You can then select a specific demo, such as a particular protocol or a UI demo showing bookmarks.

For example, the following screen display shows the initial demo page for the FFT function. To experiment with the demo, click **Load Demo....**

The screenshot shows the Keysight software interface with the FFT analysis window active. The main display area is split into two views: a time-domain waveform on the left and a spectral plot on the right. The spectral plot shows a signal with a prominent peak at -21.446 dBm. The interface includes various control panels for settings, measurements, and results.

**FFT**

This is a standard feature.

**Description**

**Key Features**

- Dedicated Spectral Viewer with controls specific to FFT functions.
- FFT waveforms are automatically placed in their own windows.
- FFT-specific scales make documentation very easy.
- An easy "Mark Peaks" function to quickly label peaks.

Label	Horizontal	Vertical	Popup Content
Pe	-1.000 Ts	0.0 V	
Pe	-1.000 Ts	0.0 V	
Pe	-1.000 Ts	0.0 dBm	
Pe	-1.000 Ts	0.0 dBm	

Figure 25 FFT Demo



# Index

## A

- accessing
  - online help, 45
- accessories
  - and options, 10
- acquisition
  - starting and stopping, 34
- adjusting
  - analog channel's vertical offset, 38
  - analog channel's vertical scaling, 38
- airflow requirements, 12
- application software, 19
- associating measurement results with waveforms, 40
- Autoscale, 18, 32

## B

- buttons, 28
  - help, 47

## C

- calibration
  - output, 18
- cautions
  - cleaning, 21
- channel keys, 38
- channels
  - controlling digital channels, 42
  - turning on or off analog channels, 38
- checking the oscilloscope, 10
- cleaning the oscilloscope, 21
- Clear Display key, 33
- clearing the display, 33
- color
  - use of, 28, 40
- configuration
  - default, 18
  - edge trigger, 39
- configuring
  - quick measurements, 33
- connecting
  - LAN card, 13
  - MSO cable, 13
  - pointing device, 13
  - power, 14
  - probes, 15

## contents

- online help, 45
- contents topic, 45
- customizing display layout, 40
- cycling
  - measurements through channels, 33

## D

- default setup, 18
- disk
  - hard disk recovery, 44
- display
  - clearing, 33
- display layout
  - customizing, 40
- drag-and-drop measurements, 40

## E

- edge trigger
  - setting, 39
- erasing the display, 33

## F

- finding information, 45, 47
- front panel
  - connections, 15
  - interface, 23, 28

## G

- grid mode, 29

## H

- hard disk
  - recovery, 44
- help
  - button, 47
- horizontal
  - zoomed timebase, 36
- horizontal position
  - in zoom mode, 36
- hyperlinks
  - using to find information, 47

## I

- information
  - methods for accessing, 45
- inspecting the oscilloscope, 10
- installing
  - application software, 19

## K

- keys, 28
  - analog channel, 38
  - Clear Display, 33
  - Markers, 41
  - Multi Purpose, 33
  - Run, 34
  - Single, 34
  - Stop, 34
  - Zoom, 36
- knobs, 28
  - analog channel's vertical offset, 38
  - analog channel's vertical scaling, 38
  - trigger level, 39

## L

- LAN card, 13
- LED indicators, 28
- level
  - trigger, 39
- line voltage, 14

## M

- magnifying
  - a section of the waveform, 36
- main timebase, 36
- making
  - measurements, 40
  - quick measurements, 33
  - waveform bigger or smaller, 38
- markers
  - and measurements, 40
  - positioning, 41
  - turning on or off, 41
- measurement results
  - associating with waveform, 40
- measurement toolbar, 40

measurements, [40](#)  
 and markers, [40](#)  
 quick, [33](#)  
 using markers, [41](#)  
 methods for accessing information, [45](#)  
 mouse  
   connecting, [13](#)  
 moving  
   markers, [41](#)  
   waveform vertically, [38](#)  
 MSO cable, [13](#)  
 Multi Purpose key, [33](#)

## N

navigating the online help, [47](#)  
 notes  
   online help access, [45](#)  
   online help windows, [46](#)  
 notices, [2](#)

## O

offset  
   adjusting analog channels, [38](#)  
 online help  
   accessing, [45](#)  
   navigating, [47](#)  
   overview, [45](#)  
   windows, [46](#)  
 opening the online help, [45](#)  
 options  
   and accessories, [10](#)  
 oscilloscope  
   cleaning, [21](#)  
   inspecting, [10](#)  
   using, [23](#)  
 oscilloscope front panel, [28](#)  
 oscilloscope operation  
   verifying, [18](#)  
 oscilloscope probes, see probes

## P

pointing device  
   connecting, [13](#)  
   verifying operation, [18](#)  
 pollution degree, [11](#)  
 position  
   adjusting analog channel's vertical, [38](#)  
 positioning markers, [41](#)  
 power  
   connecting, [14](#)  
   requirements, [14](#)  
   turning off, [21](#)  
 preset measurements, [33](#)  
 probes  
   connecting, [15](#)  
 probing a circuit, [15](#)

## Q

quick measurements, [33](#)

## R

RJ-45 connector, [13](#)  
 LAN card, [13](#)  
 Run key, [34](#)

## S

scaling  
   adjusting analog channel's vertical, [38](#)  
 seconds per division  
   in zoom mode, [36](#)  
 setting  
   edge trigger, [39](#)  
 setup  
   default, [18](#)  
 Single key, [34](#)  
 slope  
   trigger, [39](#)  
 source  
   trigger, [39](#)  
 starting and stopping acquisition, [34](#)  
 status indicators  
   trigger, [39](#)  
 Stop  
   key, [34](#)

## T

toolbars  
   measurement, [40](#)  
 topics  
   contents, [45](#)  
   navigating, [47](#)  
 tracking waveforms  
   using markers, [41](#)  
 trigger  
   level, [39](#)  
   setting edge, [39](#)  
   slope, [39](#)  
   source, [39](#)  
   status indicators, [39](#)  
 triggered sweep, [39](#)  
 turning analog channels on or off, [38](#)  
 turning markers on and off, [41](#)

## U

use of color in interface, [28, 40](#)  
 user interface  
   front panel, [28](#)  
   use of color, [28](#)  
 user interface elements, [47](#)

using  
   hyperlinks, [47](#)  
   markers, [41](#)  
   oscilloscope, [23](#)

## V

verifying basic operation, [18](#)  
 vertical inputs  
   overdriving, [30](#)  
 vertical offset  
   adjusting analog channels, [38](#)  
 vertical scaling  
   adjusting analog channels, [38](#)  
 volts per division  
   adjusting, [38](#)

## W

waveform  
   magnifying, [36](#)  
 waveform features  
   measurements on, [40](#)  
 waveforms  
   acquiring, [34](#)  
   associating with measurement  
     results, [40](#)  
   drag-and-drop measurements on, [40](#)  
   making quick measurements, [33](#)  
   measuring using markers, [41](#)  
   turning off, [38](#)  
 window  
   zoom, [36](#)  
 windows  
   online help, [46](#)  
 Windows operating system settings, [20](#)

## Z

zoom display, [36](#)  
 Zoom key, [36](#)





This information is subject to change without notice.

© Keysight Technologies 2015

March 2015



54919-97000  
[www.keysight.com](http://www.keysight.com)